

TP-1525 統一招牌

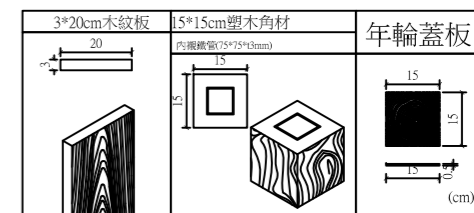

連結螺栓圖
單位：mm

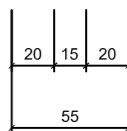
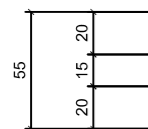
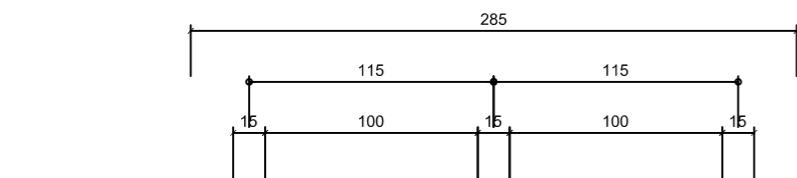

統一招牌平面圖
Scale: 1/30 ref: 全區

立柱15*15cm, 塑木(內含鐵管)
基礎位置
連結螺栓
塑木指標牌(20*100*3cmTH)
文字陰刻H=1cm上漆,內容與字形另定

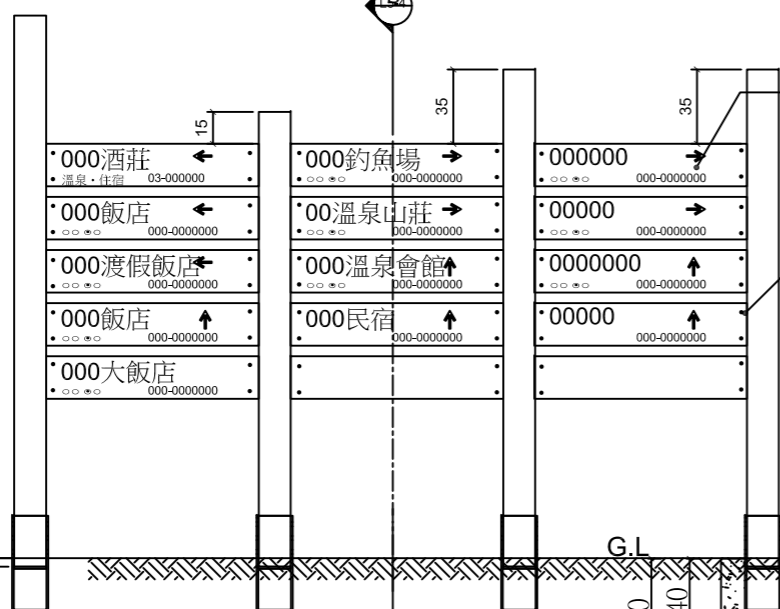
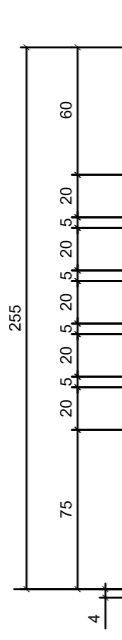
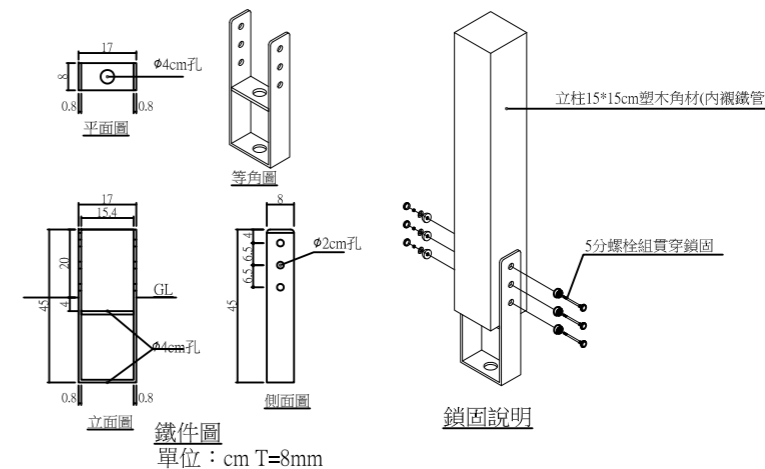

統一招牌立面圖
Scale: 1/30 ref: 全區

塑木指標牌(20*100*3cmTH)
文字陰刻H=1cm上漆,內容與字體大小另定
4分螺栓貫穿立柱連結,並以
2.5分馬車螺栓固定指標牌。
210kg/cm³混凝土
140kg/cm³混凝土

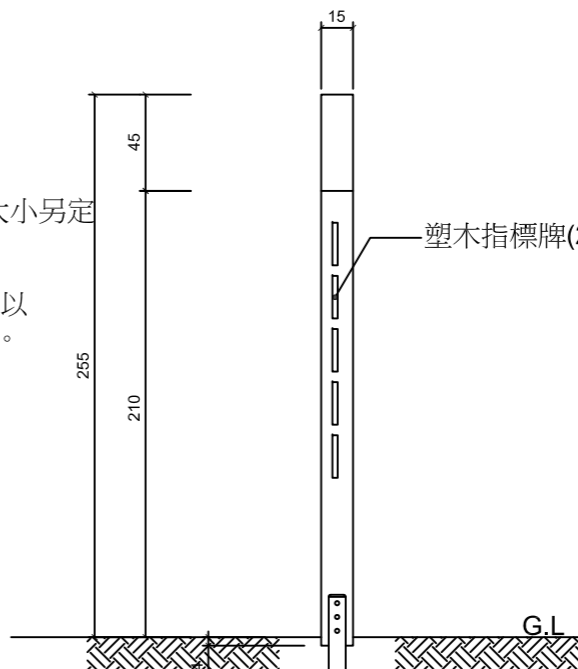

統一招牌側立面圖
Scale: 1/30 ref: 全區

版次 VER.	日期 DATE	修正者 REV. BY	修正 DESCRIPTION	初審 ACCEPTANCE REVIEWED	日期 DATE	計畫工程師 PROJECT ENGINEER	日期 DATE	繪圖 DRAWN	日期 DATE	複核 CHECKED	日期 DATE	比例尺 SCALE	1/30	工程名稱 PROJECT NAME	統一招牌施工詳圖
				審核 ACCEPTANCE CHECKED		總工程師 CHIEF ENGINEER		設計 DESIGNED		核准 APPROVED		單位 UNIT		張號 TOTAL NO.	圖號 DRAWING NO.
				複核 ACCEPTANCE RECHECKED				初核 CHECKED				檔名 FILE NAME			